

Product Description

- 170LM/W high level of lighting efficient
- LED illumination ranging from 320W to 1300W
 - The lamp with hexagon design that minimizes wind load
 - Each model operate seperately, easy to maintenance
 - Rugged die-cast aluminum adjustable bracket that can be horizontal or vertical mounted

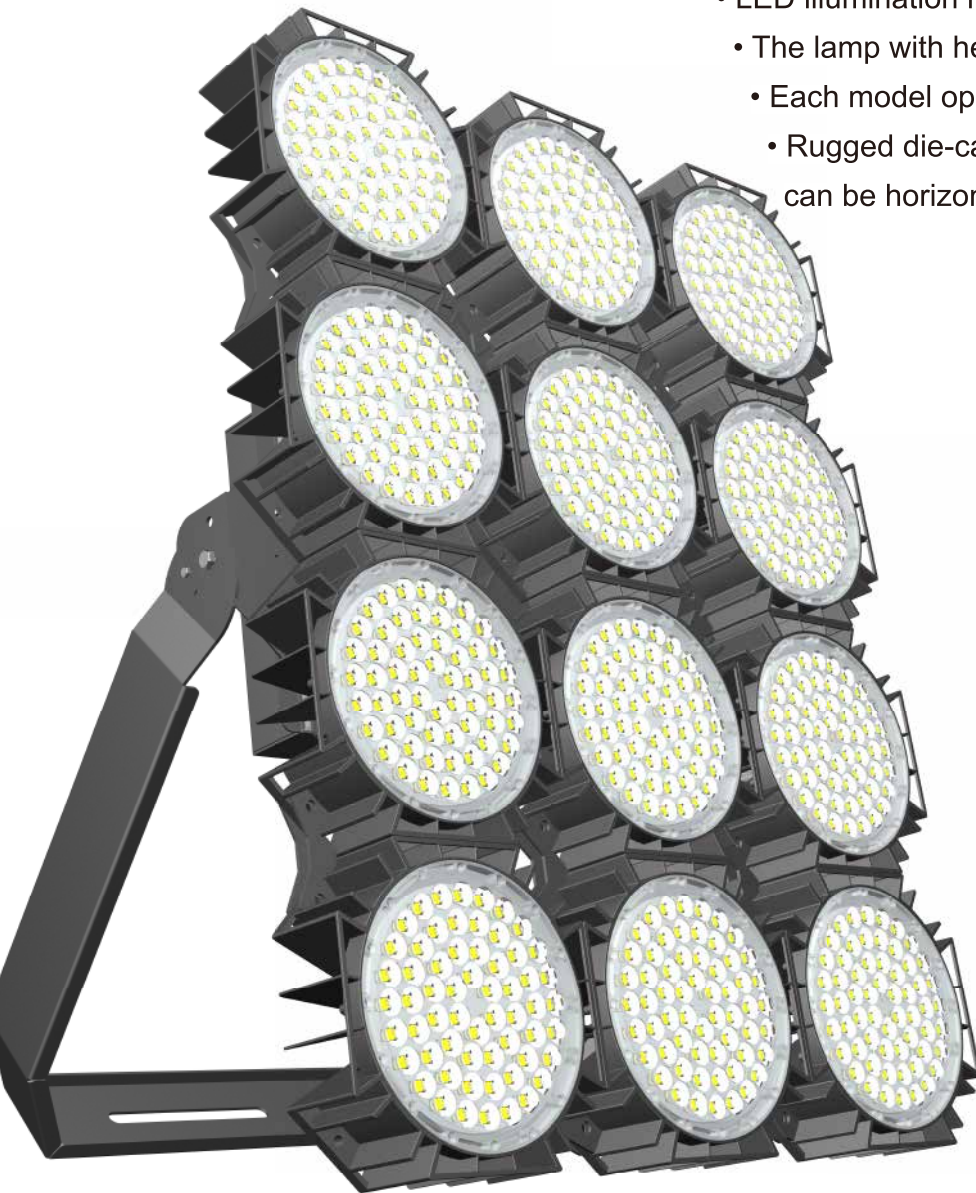

ENERG Y.IIA
енергия • енергетика

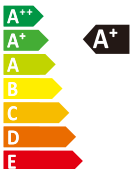

kWh/1000h

Features

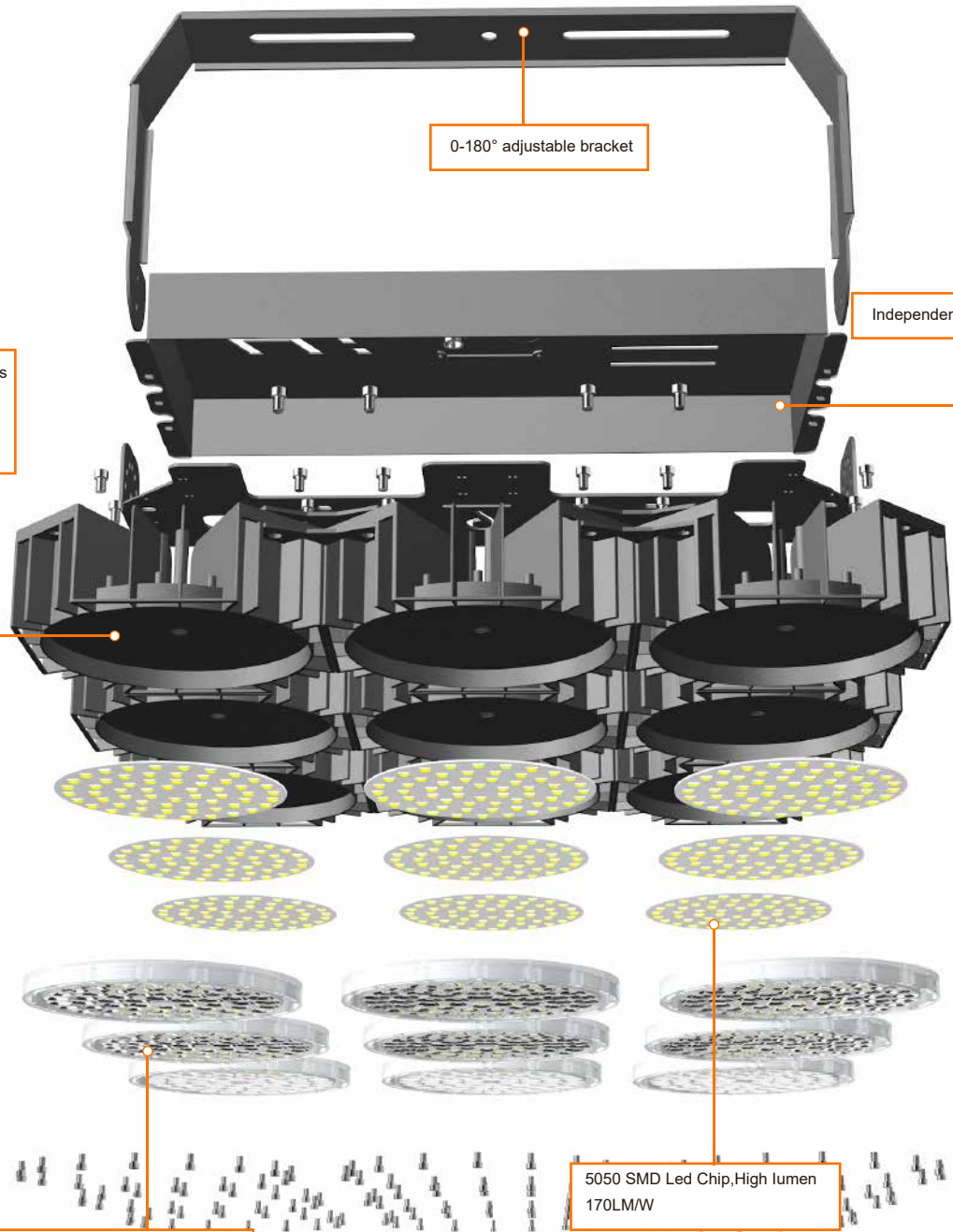

The lamp with hexagon design that minimizes wind load and saves maintenance cost. Each model operate separately, easy to maintenance

20°/30°/45° Beam Angle PC Lens
Transmittance up to 92%

SEVEN - YEAR
7
 WARRANTY

320W

SPECIFICATIONS

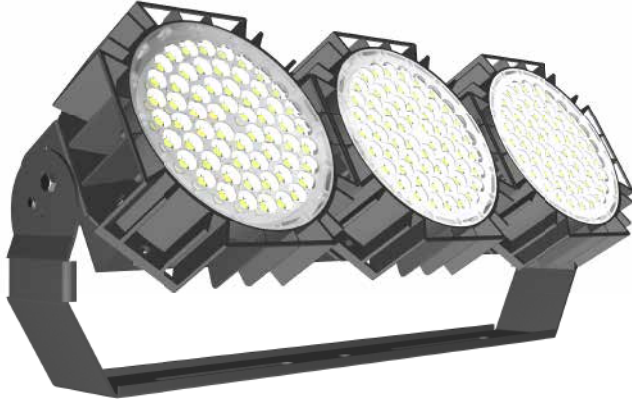

Product Dimensions

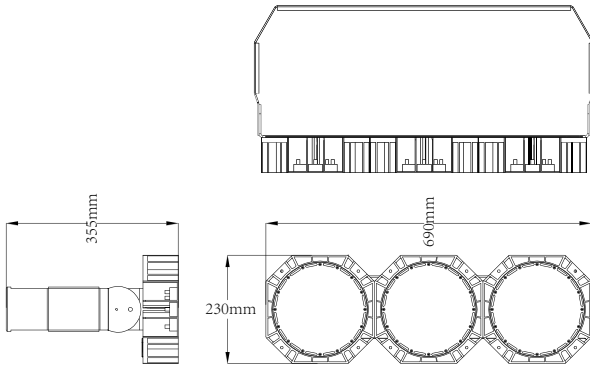

Photometrics

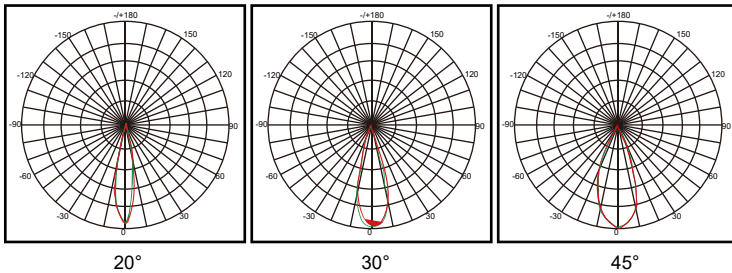

Technical Data

Model Number	HS-HM320W-A
Power	320W
Luminous Efficacy	170lm/W
Lumen Output	54400lm
LED Quantity	180pcs
Dimension	690*230*75mm
CCT	3000K 4000K 5000K 6000K (Custom Option)
CRI	>80Ra
System Efficiency	≥90%
Lens	20°/30°/45°

Electrical Details

Input Voltage	AC100-277V/347V/480V
Power Frequency	50-60Hz
Output Voltage	DC36-48V
Power Efficiency	>92%
Power Factor	≥0.95
Total Harmonic Distortion	≤15%
Dimmable	Yes (Optional)

Other Details

IP Rating	IP67
Lifespan	100,000+ Hours
Storage Temperature	-20°~65°C
Operating Temperature	-20°~55°C
Luminaire Net Weight	13KG
Certification	UL, DLC Premium, SAA, TUV, VEET, CB
Color of housing	Black (customized)

SEVEN - YEAR
7
WARRANTY



480W

SPECIFICATIONS

Technical Data

Model Number	HS-HM480W-A
Power	480W
Luminous Efficacy	170lm/W
Lumen Output	81600lm
LED Quantity	240pcs
Dimension	460*460*75mm
CCT	3000K 4000K 5000K 6000K (Custom Option)
CRI	>80Ra
System Efficiency	≥90%
Lens	20°/30°/45°

Product Dimensions

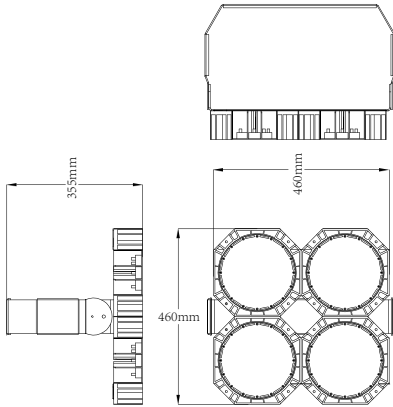

Photometrics

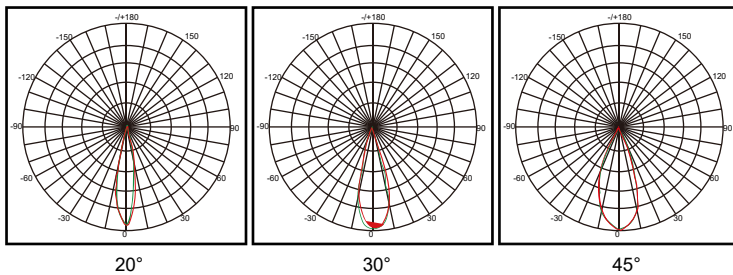

Electrical Details

Input Voltage	AC100-277V/347V/480V
Power Frequency	50-60Hz
Output Voltage	DC36-48V
Power Efficiency	>92%
Power Factor	≥0.95
Total Harmonic Distortion	≤15%
Dimmable	Yes (Optional)

Other Details

IP Rating	IP67
Lifespan	100,000+ Hours
Storage Temperature	-20°~65°C
Operating Temperature	-20°~55°C
Luminaire Net Weight	18KG
Certification	UL,DLC Premium,SAA,TUV,VEET,CB
Color of housing	Black (customized)

SEVEN - YEAR
7
WARRANTY

720W

SPECIFICATIONS

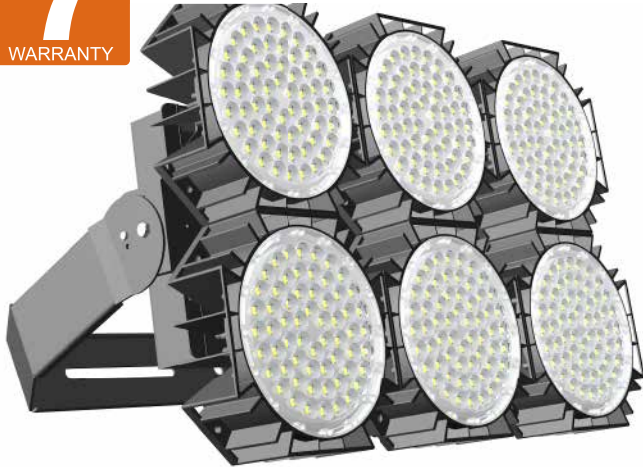

Technical Data

Model Number	HS-HM720W-A
Power	720W
Luminous Efficacy	170lm/W
Lumen Output	122400lm
LED Quantity	360pcs
Dimension	690*460*75mm
CCT	3000K 4000K 5000K 6000K (Custom Option)
CRI	>80Ra
System Efficiency	≥90%
Lens	20°/30°/45°

Product Dimensions

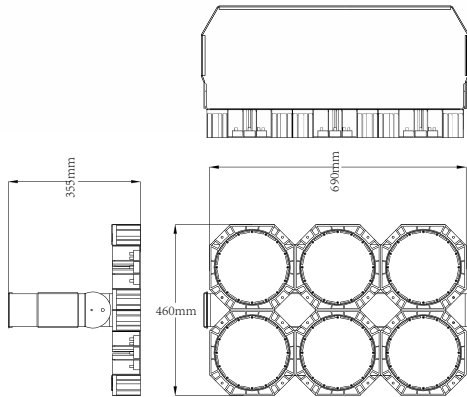

Electrical Details

Input Voltage	AC100-277V/347V/480V
Power Frequency	50-60Hz
Output Voltage	DC36-48V
Power Efficiency	>92%
Power Factor	≥0.95
Total Harmonic Distortion	≤15%
Dimmable	Yes (Optional)

Photometrics

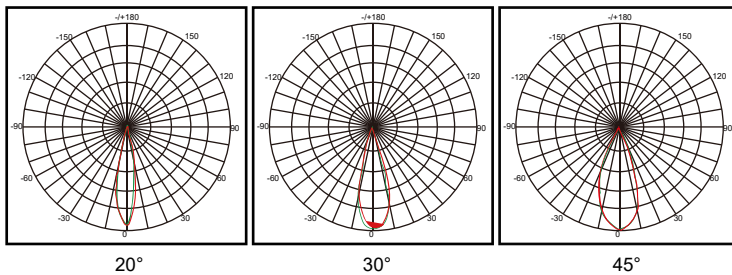

Other Details

IP Rating	IP67
Lifespan	100,000+ Hours
Storage Temperature	-20°~65°C
Operating Temperature	-20°~55°C
Luminaire Net Weight	24.5KG
Certification	UL,DLC Premium,SAA,TUV,VEET,CB
Color of housing	Black (customized)

SEVEN - YEAR
7
WARRANTY



960W

SPECIFICATIONS

Technical Data

Model Number	HS-HM960W-A
Power	960W
Luminous Efficacy	170lm/W
Lumen Output	163200lm
LED Quantity	540pcs
Dimension	690*690*75mm
CCT	3000K 4000K 5000K 6000K (Custom Option)
CRI	>80Ra
System Efficiency	≥90%
Lens	20°/30°/45°

Product Dimensions

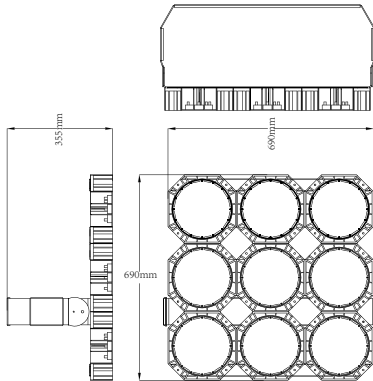

Electrical Details

Input Voltage	AC100-277V/347V/480V
Power Frequency	50-60Hz
Output Voltage	DC36-48V
Power Efficiency	>92%
Power Factor	≥0.95
Total Harmonic Distortion	≤15%
Dimmable	Yes (Optional)

Photometrics

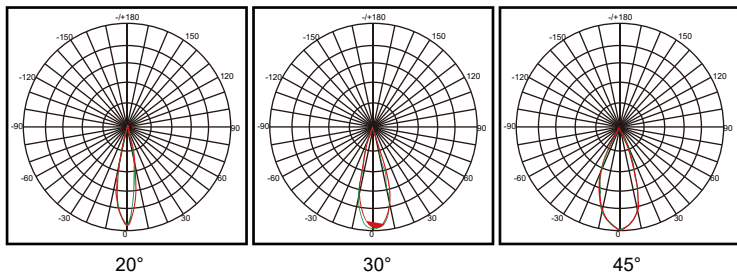

Other Details

IP Rating	IP67
Lifespan	100,000+ Hours
Storage Temperature	-20°~65°C
Operating Temperature	-20°~55°C
Luminaire Net Weight	35.5KG
Certification	UL, DLC Premium, SAA, TUV, VEET, CB
Color of housing	Brown(customized)

SEVEN - YEAR
7
WARRANTY



1300W

SPECIFICATIONS

Technical Data

Model Number	HS-HM1300W-A
Power	1300W
Luminous Efficacy	170lm/W
Lumen Output	221000lm
LED Quantity	720pcs
Dimension	920*690*75mm
CCT	3000K 4000K 5000K 6000K (Custom Option)
CRI	>80Ra
System Efficiency	≥90%
Lens	20°/30°/45°

Product Dimensions

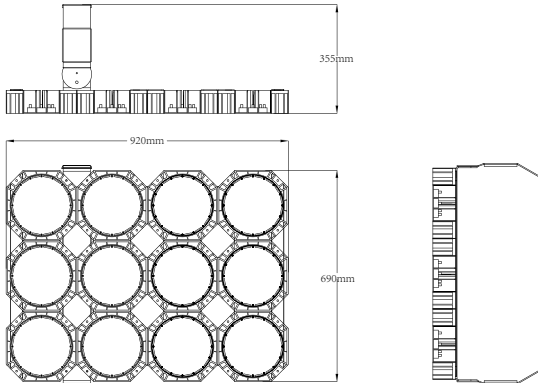

Electrical Details

Input Voltage	AC100-277V/347V/480V
Power Frequency	50-60Hz
Output Voltage	DC36-48V
Power Efficiency	>92%
Power Factor	≥0.95
Total Harmonic Distortion	≤15%
Dimmable	Yes (Optional)

Photometrics

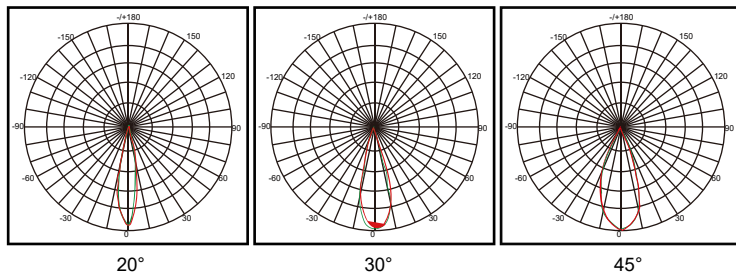

Other Details

IP Rating	IP67
Lifespan	100,000+ Hours
Storage Temperature	-20°~65°C
Operating Temperature	-20°~55°C
Luminaire Net Weight	44.5KG
Certification	UL, DLC Premium, SAA, TUV, VEET, CB
Color of housing	Brown(customized)

Installation

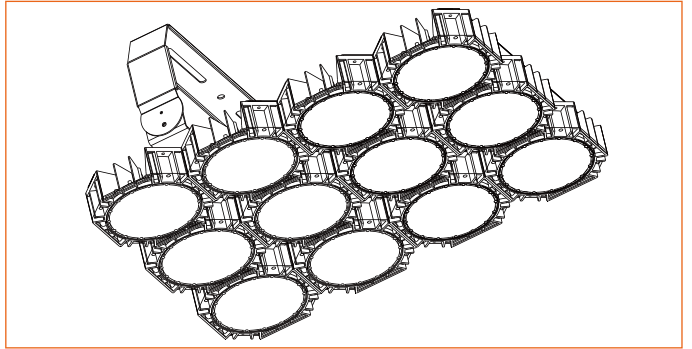
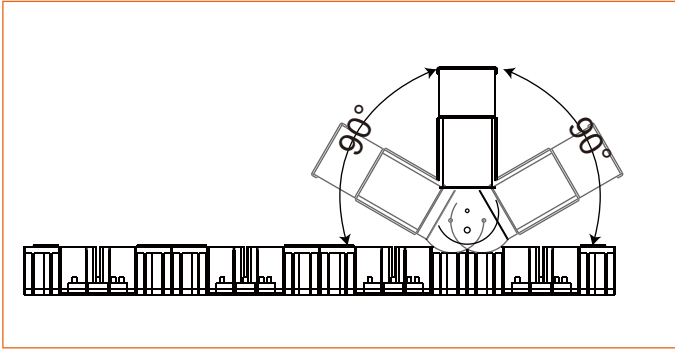

Application



Airports, Sports Lighting, Parking Areas, Rail Yards, Airport Hangers, Correctional Facilities, Harbors/Ports Treatment Plants, Security Lighting, Truck Stops, Shipyards/Docks, Highways/Interchanges.



Packing Info

Model No.	N.G(KG)	G.W (KG)	Pcs/carton	Carton Size(CM)
HS-HM320W-A	13	15	1	83*48*27
HS-HM480W-A	18	22	1	59*60*27
HS-HM720W-A	24.5	28	1	83*60*28
HS-HM960W-A	35.5	40	1	83*82*28
HS-HM1300W-A	44.5	50.5	1	108*84*28

AFTER-SALE SERVICE

Hishine Group Limited(HISHINEGR) warrants this HISHINEGR-branded hardware products against defects in materials and workmanship under normal use for a period of SEVEN(7) YEARS from the date of purchase.HISHINEGR provides free repair or replacement within the warranty period.HISHINEGR shall charge against defeats by abnormal storage,usage,connection,or change the structure or any components of the products.

*Damage by thunderstroke over 4KV(L,N against FG) / 2KV (L against N) will not covered by warranty based on IEC61000-4-5.